

ESJ01A

Single axis pilot control lever
section with 35 mm pitch

DT.ESJ01A.02

FUNCTIONS AND BENEFITS

- Compact and light weight.
- Progressive and sensitive operation.
- Precise pressure control.
- Low operating effort.
- Optimised angular movements of joystick.
- Control element protected with rubber bellow.
- High durability and maintenance free.

TECHNICAL DATA

Maximum input pressure:
100 bar - [1450 psi]

Max backpressure on tank line:
3 bar - [43.5]

Control max flow on ports:
15 l/min - [4 GPM]



ESJ01A
PITCH = 35 mm

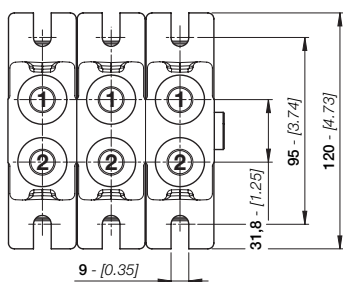

HYDRAULIC SYMBOL
Single function configuration

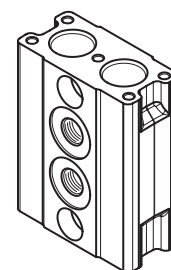
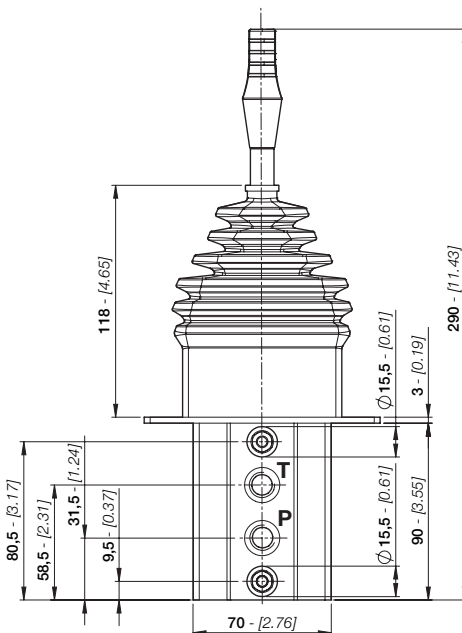
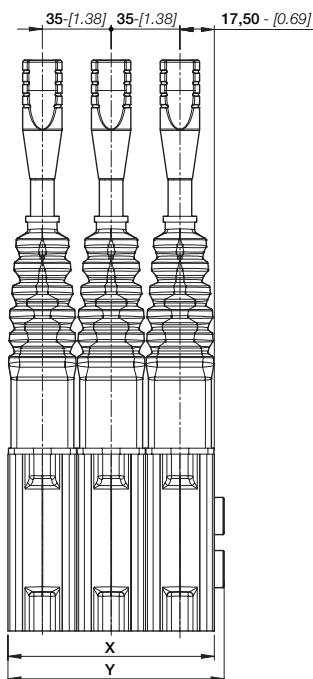
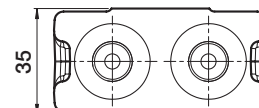
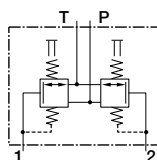

DIMENSIONS

The dimensional drawing represents a ESJ01A with 3 sections, standard assembly and BSP connections.

You can configure a ESJ01A up to 12 sections.

TYPE	BSP (ISO 1179-1)	UN-UNF (ISO 11926-1)
INLET - P	G 1/4	9/16" - 18 UNF
PORTS - 1/2	G 1/4	9/16" - 18 UNF
OUTLET - T	G 1/4	9/16" - 18 UNF

TYPE	X mm-[in]	Y mm-[in]	WEIGHT kg-[lb]
ESJ01A/1	35 - [1.38]	40 - [1.58]	1,80 - [3.97]
ESJ01A/2	70 - [2.76]	75 - [2.96]	3,60 - [7.94]
ESJ01A/3	105 - [4.10]	110 - [4.33]	5,40 - [11.25]
ESJ01A/4	140 - [5.50]	145 - [5.71]	7,20 - [15.88]
ESJ01A/5	175 - [6.90]	180 - [7.09]	9,00 - [19.85]
ESJ01A/6	210 - [8.27]	215 - [8.47]	10,80 - [23.81]
ESJ01A/7	245 - [9.65]	250 - [9.85]	12,60 - [27.78]
ESJ01A/8	280 - [11.03]	285 - [11.23]	14,40 - [31.75]
ESJ01A/9	315 - [12.41]	320 - [12.61]	16,20 - [35.72]
ESJ01A/10	350 - [13.79]	355 - [13.99]	18,00 - [39.70]
ESJ01A/11	385 - [15.17]	390 - [15.37]	19,80 - [43.66]
ESJ01A/12	420 - [16.55]	425 - [16.75]	21,60 - [47.63]

ESJ01A

Single axis pilot control lever section with 35 mm pitch



TYPICAL CURVES

All ESJ01A servocontrols are equipped with 2 metering curves (one metering curve each service port). The metering curve classification depends on the control pressure (bar - psi) and stroke length (mm - in).

Currently two types of metering curves are available:

- **Linear curve with step (MV type)**
- **Linear curve without step (MZ type)**

All metering curves are interchangeable.

MV linear curve with step

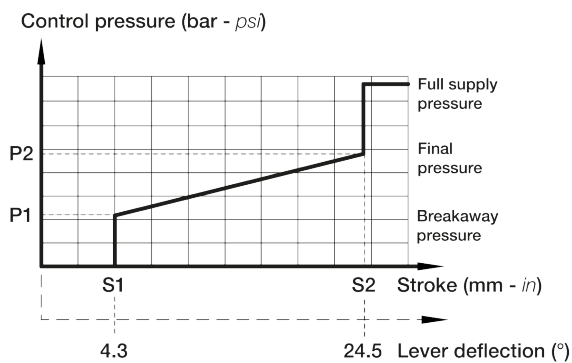

MZ linear curve without step

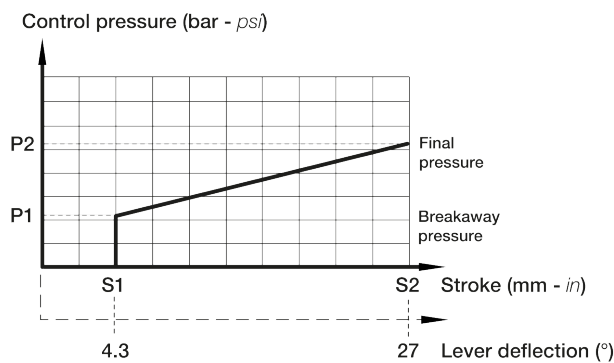

FULLY INTERCHANGEABLE WITH MOST OF COMPETITOR'S JOYSTICKS

APPLICATIONS

EBI motion controls servocontrols joysticks are used to control the work and drive hydraulics of modern mobile machines with high accuracy, safety and optimal performance.

ESJ01A are suited for specialized applications for a variety of mobile equipment such as:



OPTIONAL FEATURES

- On request are available broken line metering curves with step and broken line metering curves without step.
- To space the sections and allow the correct control of the handles, it is possible to set up the joystick with an intermediate spacer. It is identified by the code BJA0.